

左(Left) 型号 (MODEL) : M3-251510G

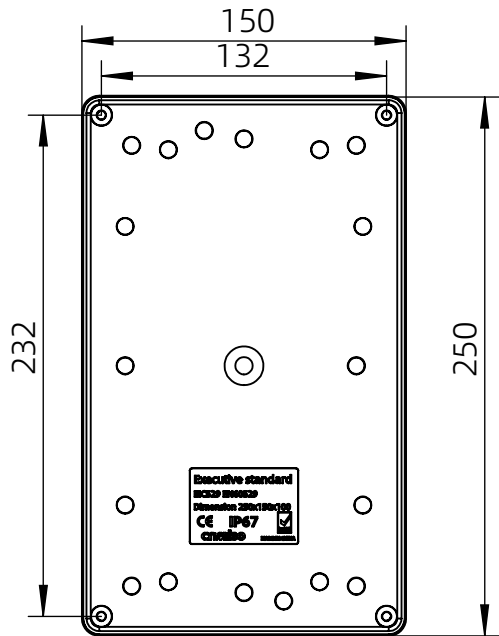

右(Right) 型号 (MODEL) : M3-251510T



背面 (Bottom)

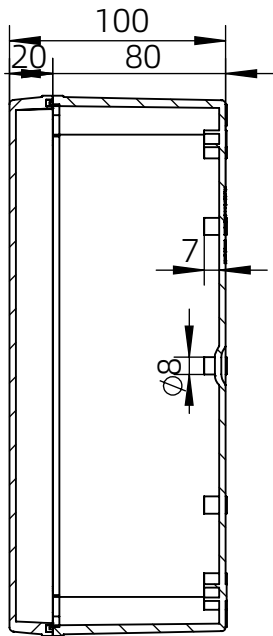

长侧边 (Side section)

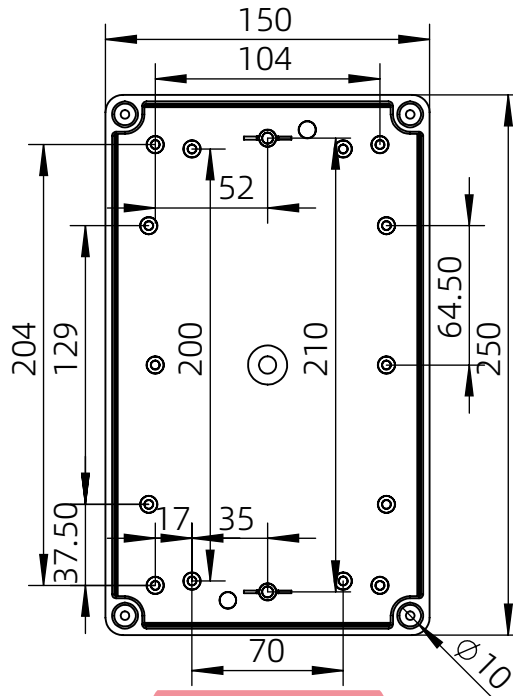

内部 (INSIDE)

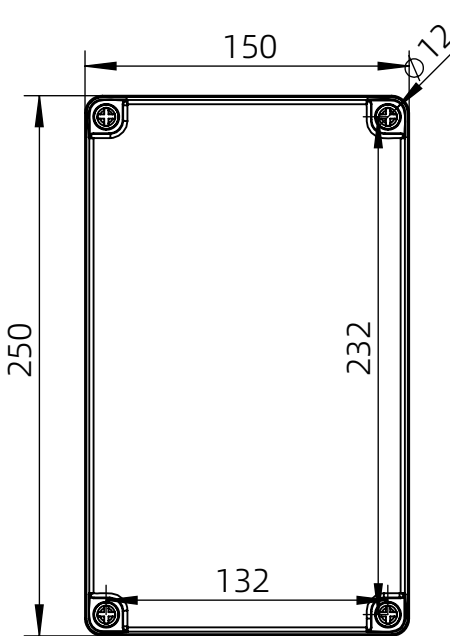

盖子 (Top)

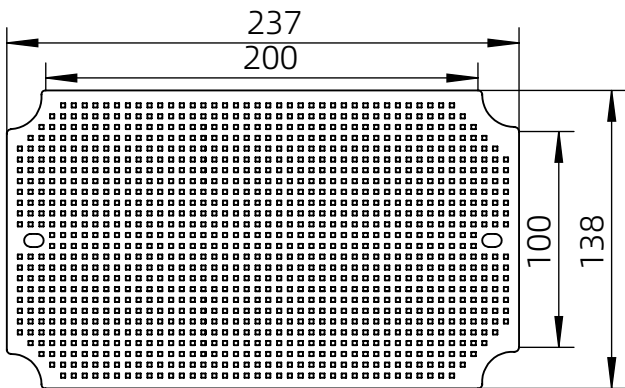

底板 (floor)

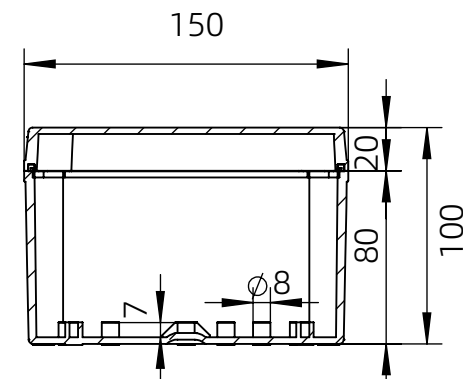
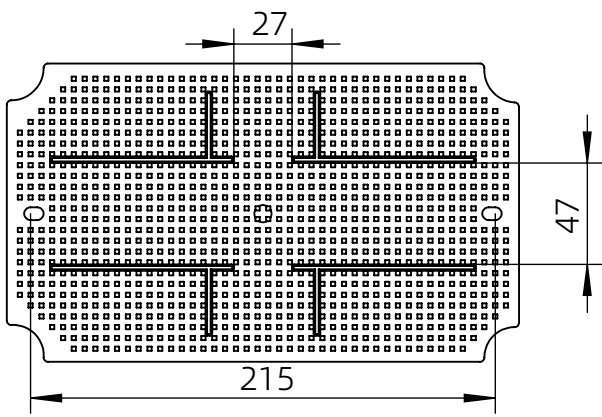

短侧边 (Side section)

品牌 (BRAND)	tongou	
型号 (MODEL)	M3-251510G	M3-251510T
材质 (MATERIAL)	ABS	Top:PC Bottom:ABS
防水等级 (LEVEL)	IP67	
尺寸 (SIZE)	250*150*100mm	